

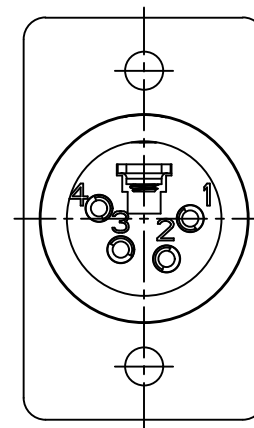

Panel cut out (Rear side)

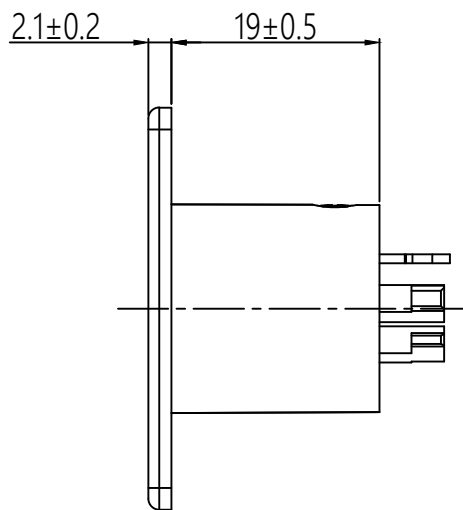
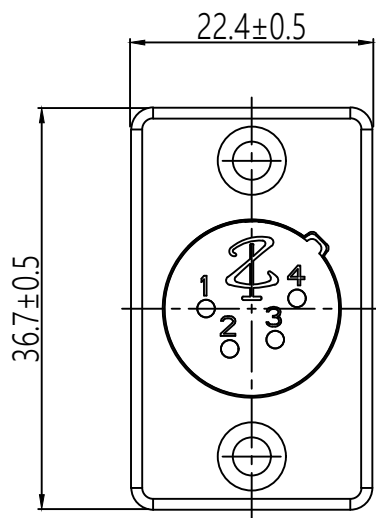
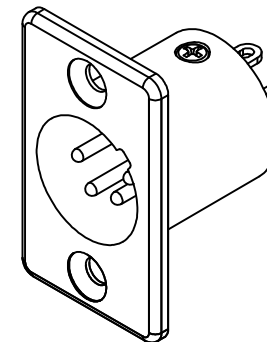
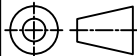

機種 MODER	<b>XR1080</b>	料號 PART NO.	1108002-040201	圖號 DWG NO.	<b>XR1080-4P</b>	製圖 DRAWER	Andy Lin	 Symbol for third angle projection	 <b>帝公企業股份有限公司</b> KING NET ENTERPRISE CO.,LTD. TEL:06-3557301 FAX:06-3557435
品名 TITLE	1080-4 pole XLR male receptacle	版本 VERSION	<b>A</b>	比例 RATIO	<b>1:2</b>	日期 DATE	2021/11/24		