

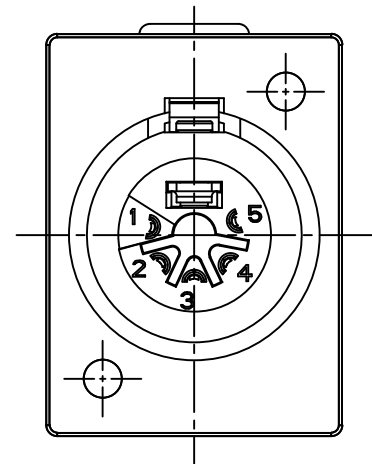

Panel cut out(Front side)

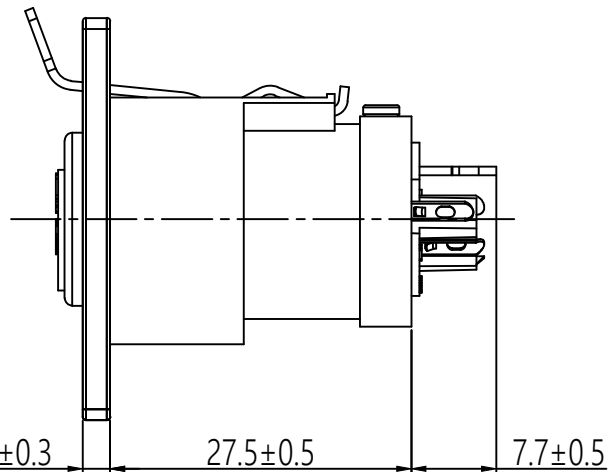
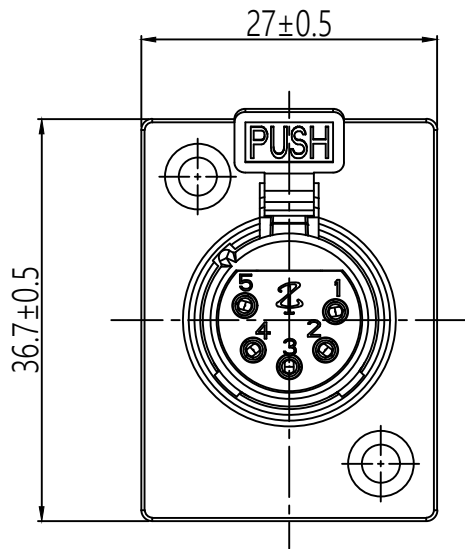
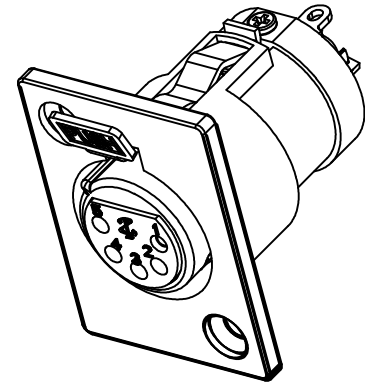

機種 MODER	XR1070	料號 PART NO.	1107002-050201	圖號 DWG NO.	XR1070-5P	製圖 DRAWER	Andy Lin	Symbol for third angle projection	 帝公企業股份有限公司 KING NET ENTERPRISE CO.,LTD. TEL:06-3557301 FAX:06-3557435
品名 TITLE	1070-5 pole XLR female receptacle		版本 VERSION	A	比例 RATIO	1:2	日期 DATE	2021/11/24	