

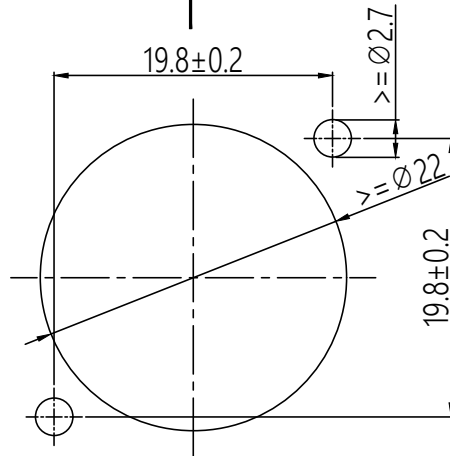

PCB-LAYOUT (component side)

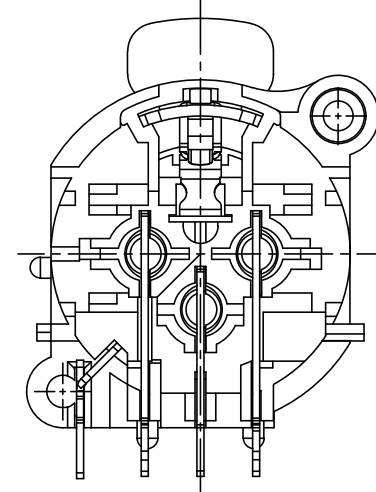

Panel cut out (Rear side)

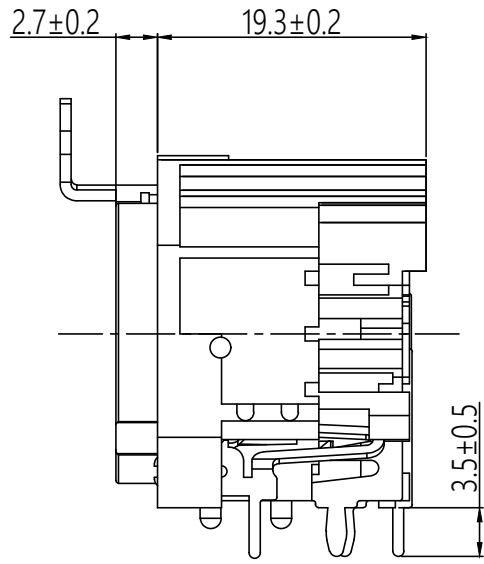
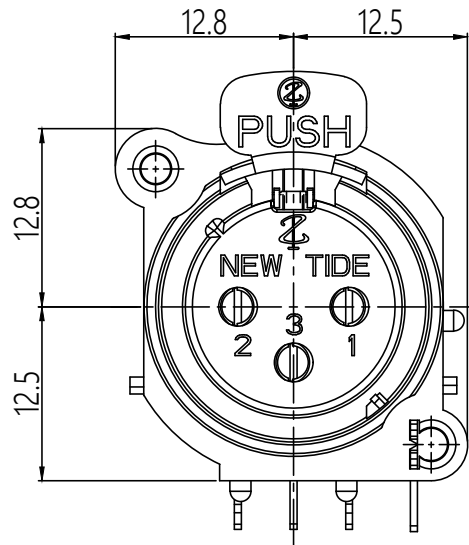
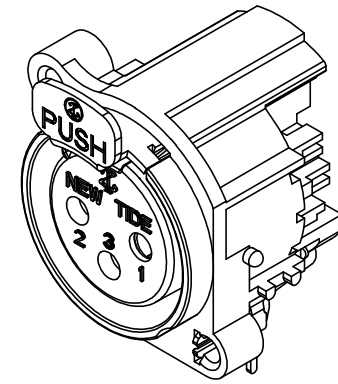

機種 MODER	XR0376	料號 PART NO.	1037608-030303	圖號 DWG NO.	XR0376-2	製圖 DRAWER	Andy Lin	Symbol for third angle projection	 帝公企業股份有限公司 KING NET ENTERPRISE CO.,LTD. TEL:06-3557301 FAX:06-3557435
品名 TITLE	0376 3-pole XLR female receptacle		版本 VERSION	A	比例 RATIO	1:2	日期 DATE	2021/11/24	