

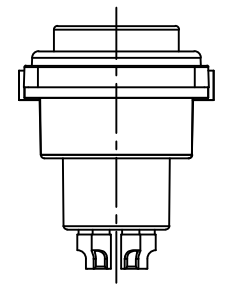

Panel cut out (Front side)

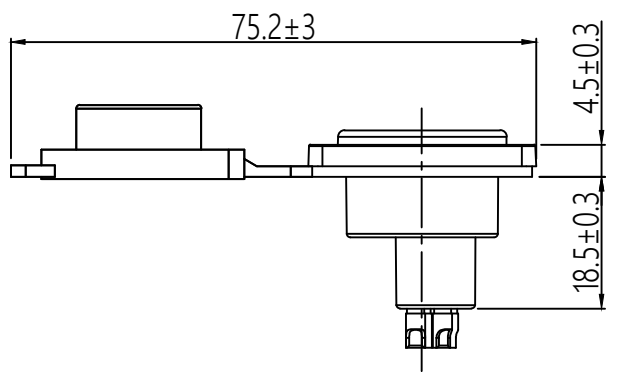
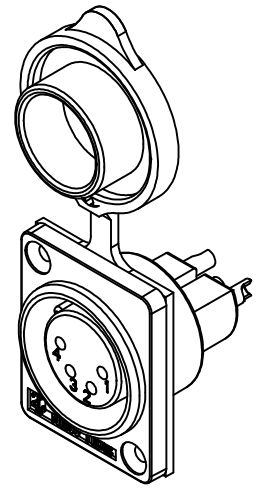
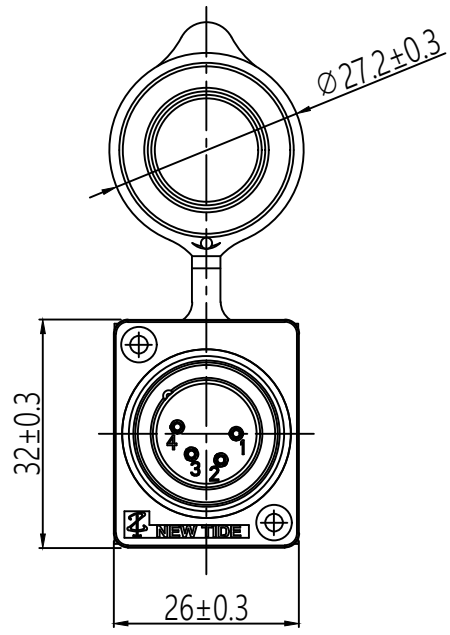

機種 MODER	XR0075	料號 PART NO.	1007508-040702	圖號 DWG NO.	XR0075-4P	製圖 DRAWER	Andy Lin	Symbol for third angle projection	 帝公企業股份有限公司 KING NET ENTERPRISE CO.,LTD. TEL:06-3557301 FAX:06-3557435
品名 TITLE	0075-4 pole XLR Plastic Chassis Connector	版本 RELEASE	A	比例 RATIO	1:1	日期 DATE	2022/06/14		