

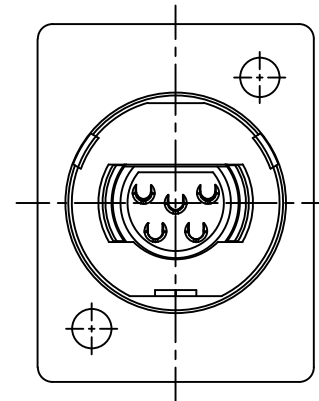

Panel cut out (Rear side)

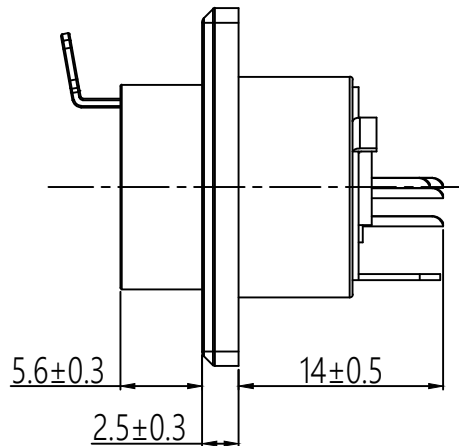
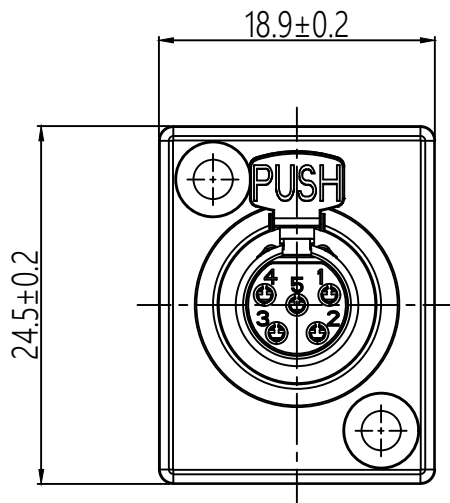
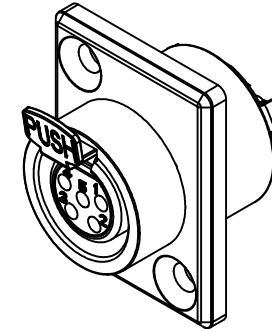
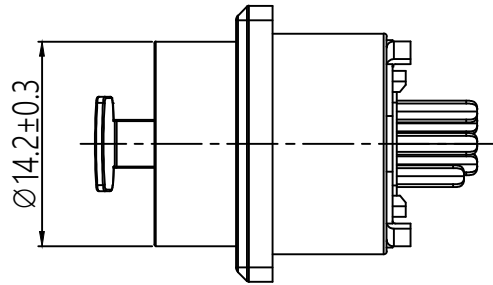

機種 MODER	MXR5070	料號 PART NO.	1507002-050301	圖號 DWG NO.	MXR5070-5P	製圖 DRAWER	Andy Lin	Symbol for third angle projection	 帝公企業股份有限公司 KING NET ENTERPRISE CO.,LTD. TEL:06-3557301 FAX:06-3557435
品名 TITLE	5070-5 pole MINI XLR Chassis Connector		版本 VERSION	A	比例 RATIO	1:2	日期 DATE	2022/07/13	